

### TECHNICAL DATA

<b>RATED FLOW [M3/H]</b>	8m3/hr
<b>MAX FLOW</b>	12m3/hr
<b>MAX HEAD</b>	161.8M
<b>OPTIMUM OPERATING RANGE</b>	4.8m3/hr @ 150.1m 44.2% eff 10m3/hr @ 127.7m 61.5% eff
<b>WORKING AIR TEMP</b>	0°C - 40°C
<b>LIQUID TEMPERATURE</b>	-15°C - 120°C
<b>HIGHEST EFFICIENCY</b>	64.2%
<b>MAXIMUM PUMP PRESSURE</b>	33 bar
<b>NET WEIGHT (KG)</b>	77.3kg

<b>RATED VOLTAGE/CURRENT</b>	Three phase 415V +10% - 6%
<b>RATED CURRENT</b>	11.8 amps
<b>POWER (KW)</b>	5.5kW 2 pole
<b>MOTOR IP RATING</b>	IP55
<b>MOTOR INSULATION</b>	Class F
<b>MOTOR EFFICIENCY STD</b>	I.E.3
<b>MOTOR EFFICIENCY</b>	88.2%
<b>COS Ø</b>	0.88
<b>MECHANICAL SEAL</b>	AS-L-16
<b>OUTLET DIN FLANGE</b>	DN40

### DIMENSIONS

<b>HEIGHT A</b>	414
<b>DIAMETER B</b>	259
<b>RADIUS C</b>	192

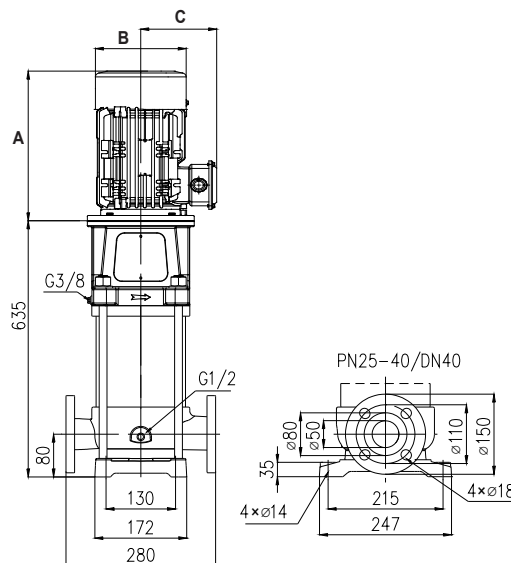

**CURVE**

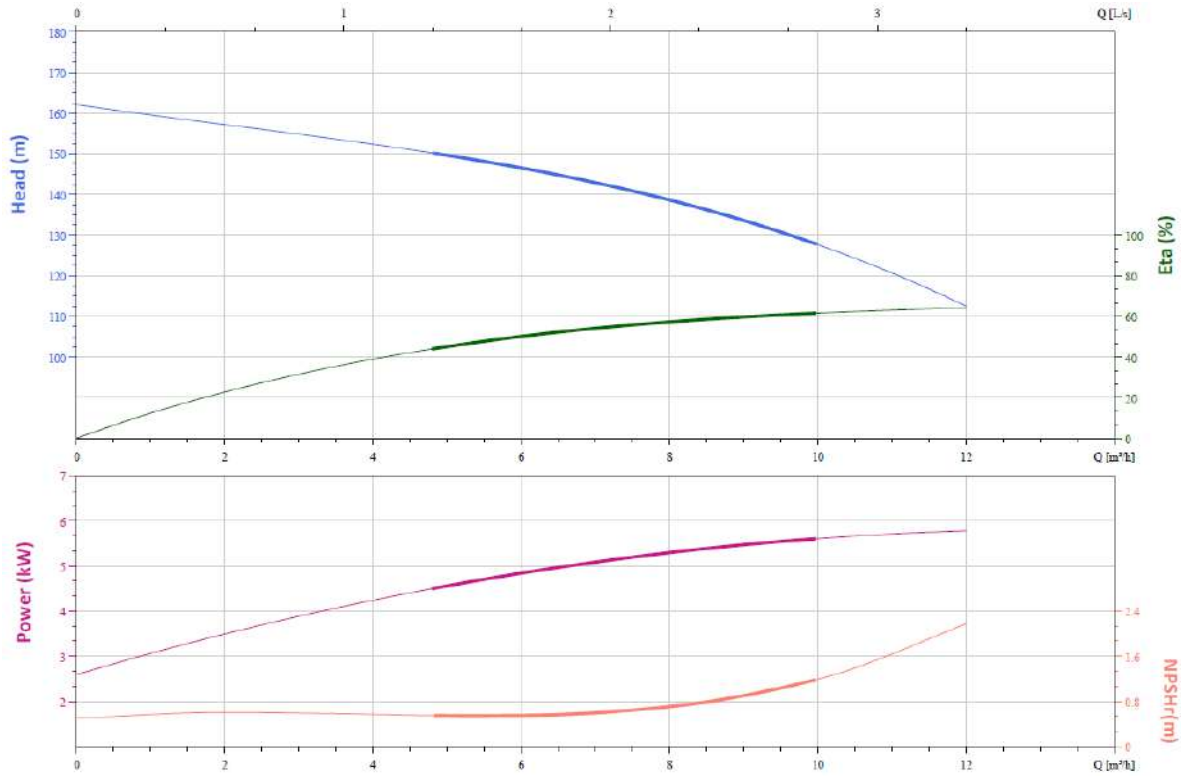

**VFD CURVE**

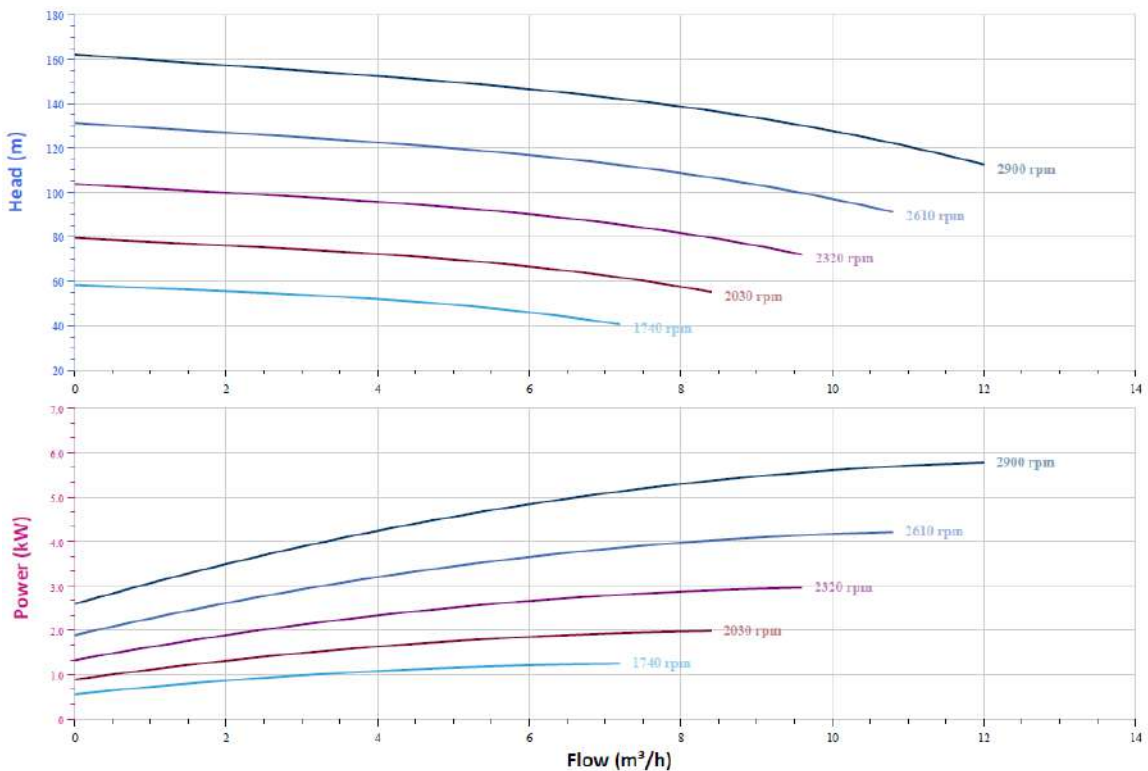

## DUAL PUMP CURVE

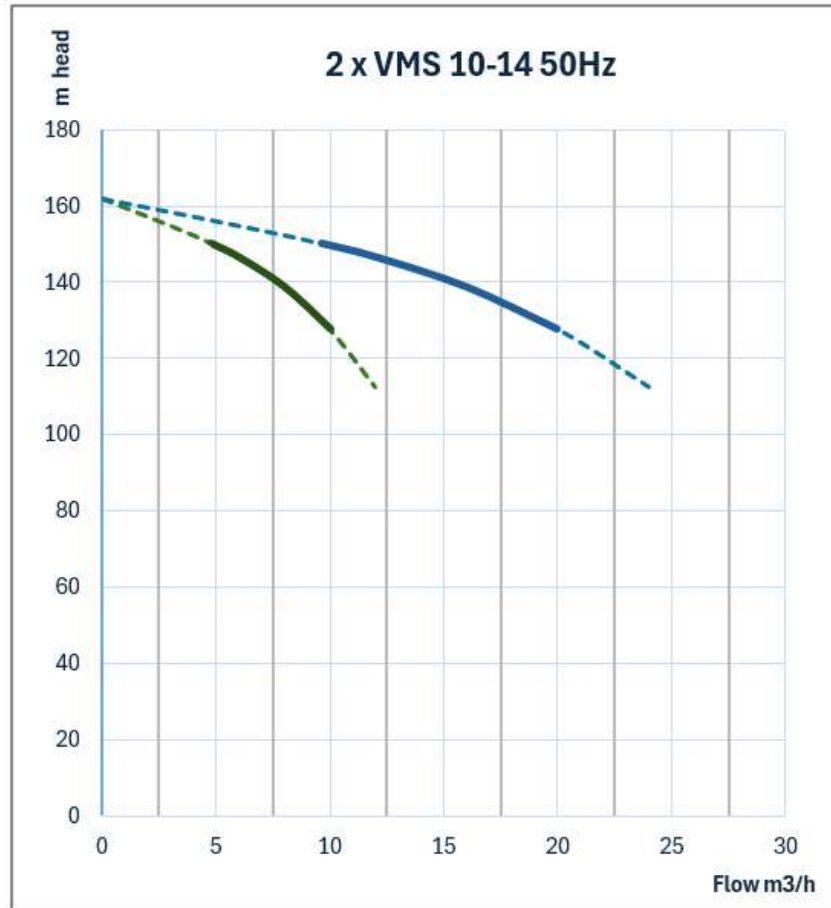

## CUTAWAY AND MATERIALS

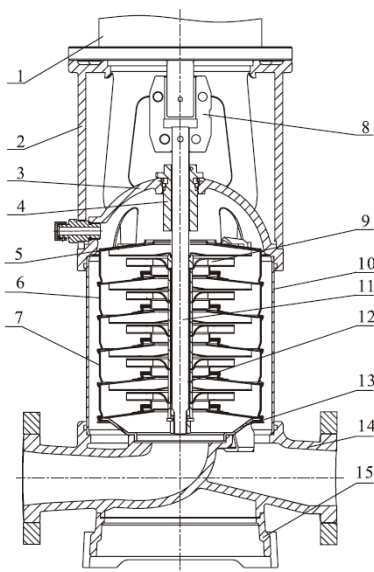

1	Motor	/
2	Bracket	Ductile Cast Iron
3	Seal Base	Stainless / Ductile Cast Iron
4	Mechanical Seal	AS-L-16
5	Top Diffuser	Stainless Steel
6	Diffuser	Stainless Steel
7	Support Diffuser	Stainless Steel
8	Coupling	Stainless Steel
9	Impeller	Stainless Steel
10	Cylinder	Stainless Steel
11	Shaft	Stainless Steel
12	Intermediate Bearing	SIC / WC
13	Inducer	Stainless Steel
14	Inlet/Outlet Chamber	Stainless Steel / Ductile Cast Iron
15	Base	Ductile Cast Iron

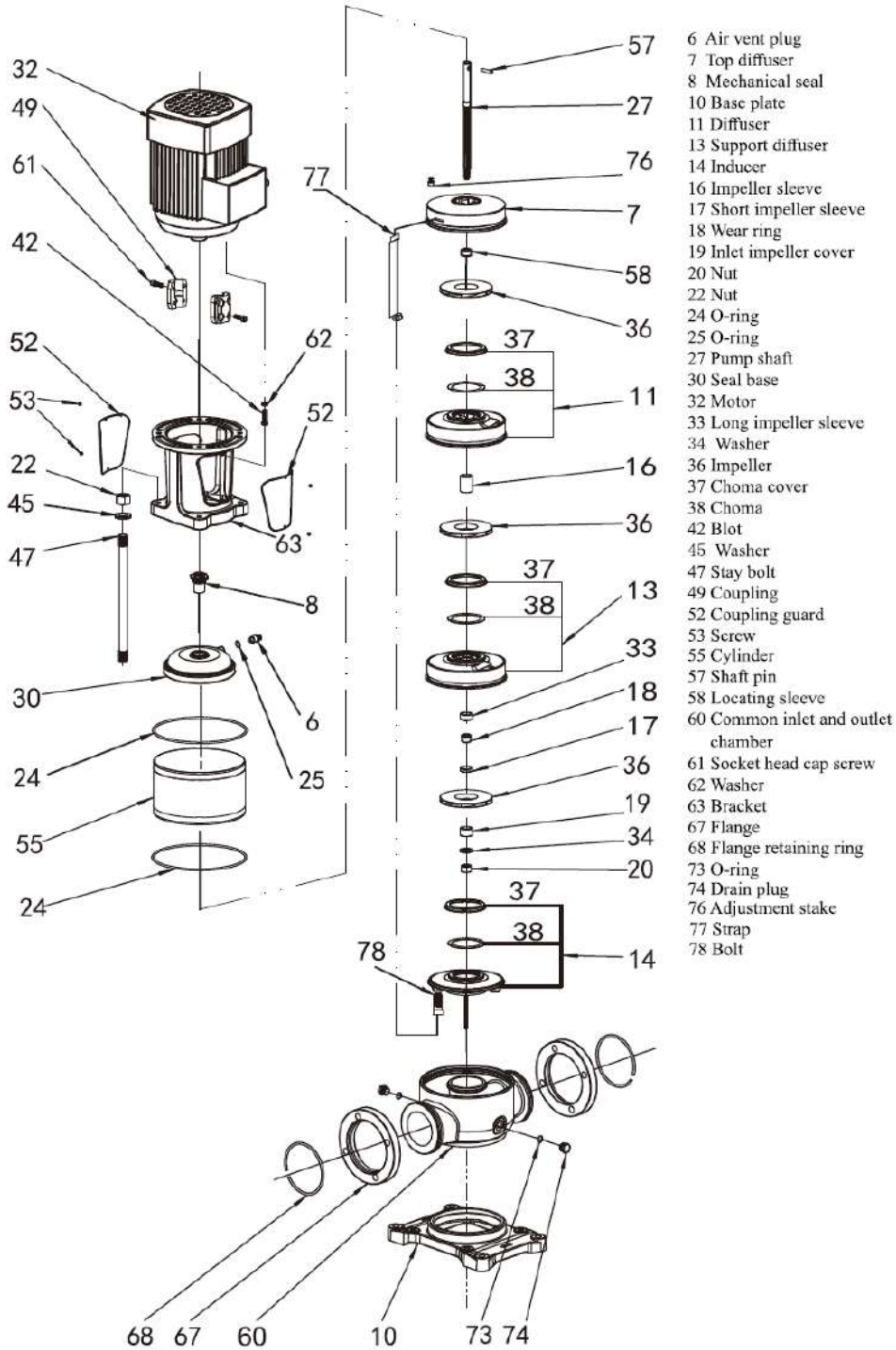

**WARRANTY / CERTIFICATIONS**

